

CONTENTS

- 2. Introduction
- 3. Baja 5R
- 4. Kraken X Baja
- 6. Baja Family + Options
- 8. Savage Family + Options
- 10. Savage XS
- 12. Ken Block Family
- 14. Vorza + D8S
- 16. Jumpshot Family
- 18. Firestorm Family
- 20. Blitz + Firestorm options
- 22. Q32 Family + Mini Recon
- 24. Trophy Family
- 26. Bullet Family
- 28. Wheely King + Crawler King
- 30. HPI Racing Line-up Spotters guide
- 32. Sport 3 introduction
- 34. Sport 3 Family
- 36. Sport 3 Hoonicorn
- 38. Vaughn Gittin Jr Family
- 40. Sprint 2 Family
- 42. HPI Bodies
- 44. HPI Wheels & Tires
- 46. Electric, Nitro and Gas power!
- 48. HPI Matrix
- 53. MYhpi
- 54. HB Introduction
- 56. HB On-road
- 58. HB Off-road

WELCOME TO THE WORLD OF HPI RACING!

HPI Racing offers a deep line-up of amazing RC vehicles, ranging from monster trucks to muscle cars and desert buggies, to replica drift racers – a huge variety of cars and trucks that are designed to make you smile! When you're ready for more speed or a different look, there's a full selection of options to add more speed, more power, extra toughness or a whole new appearance to your HPI vehicle. No matter what you're looking for, HPI has got it! We hope you enjoy looking over what we've got to offer you, and welcome you to check out the full range of HPI products at hpiracing.com



TM

NORTH AMERICA
 HPI Racing
 70 Icon, Foothill Ranch,
 CA 92610. USA
 Phone : 949 753 1099
 Fax : 949 753 1098

REST OF THE WORLD
 Hobby Products International Ltd.
 19 William Nadin Way, Swadlincote,
 Derbyshire. DE11 0BB. United Kingdom
 Phone : +44 (0)1283 226570
 Fax : +44 (0)1283 552713



BAJA 5R ON-ROAD



MASSIVE GRIPPY ON-ROAD WHEELS AND TIRES

TAKING THE BAJA TO THE STREET!

The Baja 5R On-Road takes the HPI Baja concept to new heights! With a custom lowered suspension designed purely for on-road action, the Baja 5R is the perfect way to enjoy large-scale fun while burning up the pavement! The iconic 1970 Ford Mustang Boss 302 is the perfect fit for the rear-wheel drive Baja 5R, and the vintage 8-spoke wheels and Tarmac Buster tires complete the awesome muscle car look! The Baja 5R is equipped with a Fuelie 23C 2-stroke engine and 700cc fuel tank within a thick monocoque aluminum chassis, plus a steel disc brake, waterproof servos and 2.4GHz radio system.

#115123 - Baja 5R



Fuelie
 GASOLINE ENGINE



GASOLINE POWERED OFF-ROAD



NITRO POWERED ON-ROAD



NITRO POWERED OFF-ROAD



ELECTRIC POWERED OFF-ROAD



ELECTRIC POWERED ON-ROAD

©Hobby Products International Ltd 2016. Our catalogues, instructions, leaflets, manuals, drawings, specifications and price lists (information) are not an offer to create a contract. We can change them and correct any clerical error without any liability to you. HPI Racing® is a Registered Trademark of Hobby Products International Ltd.



Baja 5B SX5

*Option tires shown

SIDEWINDER X5



DUNE BUGGY LOOKS ON THE BAJA 5B!

HPI Racing and HPI Baja aftermarket specialists Kraken RC have joined forces to provide large scale enthusiasts with a fully built and painted Baja 5B fitted with Kraken RC roll cages straight from the factory! For fans of the classic dune buggy, the modern equivalent is the awesome 'sand rail', a tube frame buggy that takes no prisoners when blasting up and over massive sand dunes! The Kraken RC Sidewinder X5 conversion adds a fully functional roll cage and body panels to the Baja 5B chassis, transforming it into a scale replica of the latest generation of desert play vehicles.

#115484 - Baja 5B Kraken SX5 Sidewinder X5



Baja 5B

TSK-b CLASS 1



PURE DESERT RACING ACTION WITH THE BAJA 5B!

HPI and Kraken RC have teamed up to provide an awesome 'Class 1' racing style Baja 5B: the Kraken RC TSK-b Class 1 conversion! This is another transformation that turns the Baja 5B into a perfect scale replica of the newest generation of desert racing vehicles, just like the ones that compete in hardcore endurance races like the Baja 1000 in the unlimited 'Class 1' specification. The Kraken RC TSK-b Class 1 conversion adds a tough full roll cage made of polymer plastic plus realistic body panels to turn the Baja 5B into an awesome racing buggy!

#115485 - Baja 5B Kraken TSK-b Class 1



Fuelie
GASOLINE ENGINE
26 CC

BOTH BAJAS INCLUDE HD OPTIONS

BOTH BAJAS INCLUDE **DURA CAGE MODULAR TECHNOLOGY**



Fuelie
GASOLINE ENGINE
26 CC

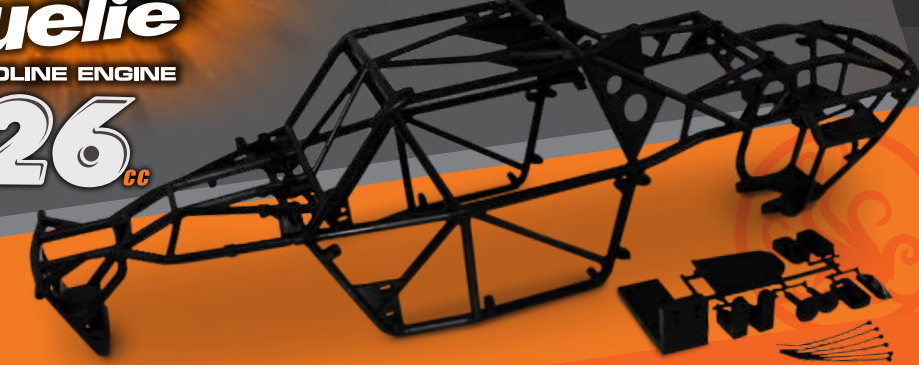



Baja 5B 2.0

D-BOX 2

ADJUSTABLE STABILITY CONTROL SYSTEM



#110190
RTR Baja 5B 2.0

Fuelie
GASOLINE ENGINE

Baja 5B SS



#112457 Baja 5B SS Kit
with Baja 5B-1 Clear Body



Fuelie
GASOLINE ENGINE

CHECK IT OUT **Baja**
on page 22

Baja 5SC



109964 RTR Baja 5SC

Fuelie
GASOLINE ENGINE

Baja 5T



110185 RTR Baja 5T
*Check local dealer for availability

Fuelie
GASOLINE ENGINE

Baja OPTION PARTS

Check out the full range of options for Bajas : www.hpiracing.com



#87289 - HD REAR
UPPER PLATE (7075S/
GUN METAL)



#87549 - HD FRONT
ALUMINUM SHOCK
MOUNT (7075S/GUN
METAL)



#87572 - HEAVY DUTY
ALUMINUM BRAKE
MOUNT



#87548 - HD REAR
ALUMINUM SHOCK MOUNT
BRACE (7075/GUN METAL)



#86715 - HEAVY DUTY
ALUMINUM PINION/CLUTCH
MOUNT (GUN METAL)



#86700 - ALUMINUM AIR
FILTER MAINTENANCE CAP
(ORANGE)

#85481 - HEAVY DUTY
DIFF GEAR 48 TOOTH

#86485 - HEAVY DUTY
IDLE GEAR 30 TOOTH

#86487 - HEAVY DUTY
DRIVE GEAR 20 TOOTH



#85474 - POWER
CONTROL SLIPPER
CLUTCH SET (57T)



#105409 - HPI D-BOX
2 ADJUSTABLE STABILITY
CONTROL SYSTEM

#87559 - HD ALUMINUM SPUR
GEAR MOUNT (GUN METAL)

WHEELS & TIRES FOR ALL BAJA MODELS



#4740 - MOUNTED SAND
BUSTER RIB TIRE M COMPOUND



#4741 - MOUNTED SAND BUSTER
PADDLE TIRE M COMPOUND



#4742 - MOUNTED TARMAC BUSTER
RIB TIRE M COMPOUND (FRONT)



#3270 - HEAVY DUTY WHEEL BEAD LOCK RINGS (WHITE/2 WHEELS)
#3271 - HEAVY DUTY WHEEL BEAD LOCK RINGS (BLACK/2 WHEELS)
#3272 - HEAVY DUTY WHEEL BEAD LOCK RINGS (SILVER/2 WHEELS)
#3273 - HEAVY DUTY WHEEL BEAD LOCK RINGS (GUN METAL/2 WHEELS)
#3275 - HEAVY DUTY WHEEL BEAD LOCK RINGS (RED/2 WHEELS)
#3276 - HEAVY DUTY WHEEL BEAD LOCK RINGS (BLUE/2 WHEELS)
#3277 - HEAVY DUTY WHEEL BEAD LOCK RINGS (YELLOW/2 WHEELS)



#87401 - ALUMINUM
TUNED PIPE SET W/ HD
STEEL HEADER (BAJA)



NEW LOOK FOR 2016!



#112609 Savage XL Flux 2.4Ghz

NEW FOR 2016!



SAVAGE X 4.6

SAVAGE OPTION PARTS



SAVAGE XL FLUX

GIANT SAVAGE LiPo POWER!

The Savage XL Flux is the BIGGEST electric truck in the HPI line-up! This massive beast is longer and wider than a standard Savage monster truck, takes twin battery packs for up to 6S power and features a massive brushless motor for awesome power and extreme speed!



SAVAGE XL OCTANE

REVOLUTIONARY GAS POWERED MONSTER TRUCK!

This truck is powered by a 15cc gasoline 2-stroke engine, making it unique not just among monster trucks but in the entire RC world! With its huge engine, 3-speed transmission, XL-size, driving times of 20 minutes and almost complete parts compatibility with the rest of the Savage 1/8th scale line-up, the Savage XL Octane is the King of the Monster Trucks!

2.7hp 15cc 2-stroke

#109073 Savage XL Octane RTR 15cc Gasoline-Powered Monster Truck



THE CLASSIC SAVAGE!

If you're looking for a super-fast, extra-acrobatic, stunt-ready monster truck, the Savage X 4.6 should be right up your street. The F4.6 engine puts out nearly 3 horsepower, giving this monster blinding acceleration for instant wheelie action, and the 2-speed transmission allows it to really stretch its legs wherever you can find room! Over a decade of refinement has led to this being the toughest nitro-powered Savage, so you can pull off big-air stunts whenever you like, over and over!

#109083 RTR Savage X 4.6 Silver/Black body



#87039 - REVERSE MODULE WITH MIXER

#86277 - HEAVY-DUTY CUP JOINT 8x14x19mm

#86276 - HEAVY-DUTY CUP JOINT 6x13x20mm

#A720 - BIG BORE ALUMINUM SHOCK SET (ASSEMBLED/SAVAGE)

#102530 - ALUMINUM WHEEL HEX HUB SET 24mm (GRAY/4pcs)

#85245 - WHEELIE BAR SET FOR SAVAGE

#86151 - HEAVY-DUTY DOGBONE 8x77mm

#86152 - HEAVY-DUTY DOGBONE 8x83mm

SAVAGE WHEELS & TIRES



#3151 - DISH WHEEL BLACK (83x56mm/2pcs)



#3188 - MAG-8 WHEEL MATTE CHROME (83x56mm/2pcs)



#3173 - 8 SPOKE WHEEL BLACK CHROME (83x56mm/2pcs)



#3117 - 6 SPOKE WHEEL SHINY CHROME (83x56mm/2pcs)



#4465 - TERRA PIN TIRES S-COMPOUND (170 x 85mm/ 2pcs)



#4874 - DIRT CLAWS TIRE B COMPOUND (145 x 84mm/ 2pcs)



#4878 - SUPER MUDDERS TIRE (165 x 88mm/ 2pcs)

SAVAGE XL

EXTRA LARGE SAVAGE!

If nitro is your game and you want big, bold and brash, the Savage XL is the one for you! With the colossally huge K5.9 engine, it's fast, loud and powerful, rumbling over obstacles that will stop nearly any other truck. Waterproof electronics and extra-strong servos, along with the 2.4GHz electronics featured in all the other Savage monster trucks, help ensure it keeps running...and running...and running!

#116050 Savage XL 5.9 RTR with Painted Body w/ 2.4GHz



SAVAGE XS FLUX

WATERPROOF

Vaughn Gittin Jr

65+ MPH
105+ km/h

UP TO
3S LiPo
POWER!



VAUGHN GITTIN JR EDITION SAVAGE XS

The Savage XS is already pretty cool-looking, but what happens when you take one of today's motorsport style icons, Vaughn Gittin Jr, and give him free reign to design his own custom Savage XS? You get this wild creation with multispoke bright green wheels and an amazing stealth-style body design! Underneath the amazing looks you still get the same amazing Savage XS spec, including a powerful motor ready for over 65 mph plus wheelies and stunts all day long!

**VAUGHN
GITTIN JR
STYLED
WHEELS &
SPRINGS**

#115967 - Savage XS Flux RTR w/ Vaughn Gittin Jr body



FORD SVT RAPTOR

THE WORLD'S FASTEST MINI-MONSTER TRUCK WITH A NEW LOOK!

Taking the Ford SVT Raptor and scaling it down without taking away its awesome performance isn't easy, but HPI have done it again with the amazing Savage XS Flux mini monster truck! With easy wheelies, backflips and 65+ mph speeds, the Savage XS is compact and full of fun! Full-time shaft-drive 4WD is the perfect way to get the power to the all-terrain wheels, while oil-filled long-stroke shocks absorb huge landings to let you keep coming back for more!

#115125 - Savage XS Flux RTR w/ Ford Raptor body

BL3CK



INTERGALACTIC HOONING

Our latest Ken Block replicas feature the amazing "Intergalactic" design from his 2015 Gymkhana GRiD competition Ford Fiesta ST RX43, letting you replicate Ken's awesome driving skills on a scale course of your own!

What is Gymkhana GRiD? It's a combination of autocross and drifting skills where drivers compete on a timed course using the speed and power of their car combined with extreme handling sections including slaloms and drifts. Drivers race head-to-head against another racer on a mirror-image course, with single eliminations knocking out drivers one by one until it's a single race for the glory!

With these amazing HPI replica cars, you can compete against your friends in 1/18th scale and 1/8th scale!



**POWERPIN
TIRES!**



WR8 3.0

KEN BLOCK'S GRiD FIESTA – NOW WITH NITRO POWER!

The jaw-dropping "Intergalactic" nitro-powered WR8 version of Ken Block's latest Gymkhana GRiD Ford Fiesta ST RX43 features HPI Nitro power that is easy, fun and exciting, with rumbling and real fuel-burning smoke at the pull of a trigger, making it a great way to copy Ken's amazing action with your friends!

#115458 WR8 3.0 RTR w/ Ken Block GRiD livery

60+

MPH 97+ km/h

*with 46/19T Pinion and 3S Battery

WR8 FLUX



MICRO RS4

Check out the full range of Ken Block options : www.hpiracing.com



BLiCK OPTION PARTS

- WR8 #108022** - ALUMINUM FRONT UPPER BRACE (HARD ANODIZED)
- WR8 #108021** - ALUMINUM REAR HUB CARRIER SET (0 DEG/ HARD ANODIZE)
- WR8 #108077** - ALUMINUM C HUB SET (HARD ANODIZED)
- WR8 #108020** - ALUMINUM LOCKING HEX WHEEL HUB (12mm/4pcs)
- WR8 #108023** - ALUMINUM FRONT BRACE (HARD ANODIZED)
- WR8 #109011** - SHOCK TOWER (WOVEN GRAPHITE/3mm)
- WR8 #108024** - ALUMINUM REAR BRACE (HARD ANODIZED)
- MICRO RS4 #72456** - UNIVERSAL DRIVE SHAFT SET (2pcs)
- MICRO RS4 #73419** - SOLID DRIVE SET
- WR8 #105409** - HPI D-BOX 2 ADJUSTABLE STABILITY CONTROL SYSTEM

MICRO SCALE GYMKHANA GRiD WITH KEN BLOCK!

Our latest Ken Block Micro car is the Gymkhana GRiD Ford Fiesta ST RX43, featuring the stunning "Intergalactic" look, and is ready right out of the box to give you awesome Micro-scale fun and excitement! Ready To Run kit features real rubber tires, coil-over shock a highly detailed scale replica Ken Block body and replica fifteen52 Turbomac wheels for an awesome scale look wherever you drive!

#115387 - Micro RS4 w/ Ken Block GRiD livery

3 EXACT REPLICAS OF KEN BLOCK'S 2015 GYMKHANA FORD FIESTA TO CHOOSE FROM!



FLUX BRUSHLESS POWER + KEN BLOCK = GRiD HOONING!

If you want to take an authentic Ken Block replica RC car from a standing start into wild GRiD action and 60+ mph (100+km/h) speeds with a simple pull of the trigger, you'll definitely want the controller of the WR8 Flux in your hands! The awesome "Intergalactic" version of Ken Block's latest Gymkhana GRiD Ford Fiesta ST RX43 is the latest WR8 Flux replica from HPI, and it's the ultimate fun machine for Ken Block fans!

#115383 - Ken Block WR8 FLUX w/ Ken Block GRiD livery



CHECK OUT THE HOONICORN on page 36

G3.0



VORZA

BRUSHLESS 1/8TH SCALE 4WD BUGGY **FLUX HP**



RECORD-SETTING VORZA FLUX HP!

With the DNA of a World Champion and the power of HPI Flux technology, the Vorza Flux HP is a born winner! Whether you want to take this racing buggy to the track or your local set of dirt jumps, the result will be the same – big smiles and head-turning stunts! Fitted with loads of standard parts from top-level HB racing buggies and a 2200KV motor, this 6S-capable buggy is ready for racing, big-air fun and much, much more.

UP TO
73+*
MPH
117+ km/h

#67210 - HIGH MOUNT REAR SHOCK TOWER (112MM)

OPTION PARTS

Check out the full range of Vorza HP and D8S options : www.hpiracing.com



#67187 - FRONT SHOCK TOWER (5MM)

#101035 - 44T CENTER SPUR GEAR

#67196 - LIGHT WEIGHT WHEEL HEX HUB (2PCS)

#67200 - LIGHT WEIGHT DIFFERENTIAL SHAFT (2PCS)

#101115 - BIG BORE SHOCK SET (97MM/2PCS)

#101116 - BIG BORE SHOCK SET (112MM / 2PCS)

#67197 - LIGHT WEIGHT OUT DRIVES (2PCS)

#67214 - ALUMINUM REAR HUB CARRIER SET

UP TO
6s LiPo POWER!
22.2v COMPATIBLE!

D8S

* See kitpage for details

#101850 - RTR Vorza Flux HP w/ 2.4GHz

WORLD CHAMPION QUALITY IN AN RTR PACKAGE

Take a World Championship-winning buggy and add in the powerful and race-legal F3.5 v2 engine, plus a winning HPI 2.4GHz radio system, and you get a fantastic race-ready buggy out of the box! The D8S gives you everything on the track that the World Champion D8 gave Team HB! The D8S has the ability to be a race winner - it just needs you at the controls! It's ready for a multitude of tuning options to dial it in for your local track and your own driving style.

#106118 - RTR D8S w/ 2.4GHz

2.5 HP
RACE LEGAL
NITRO STAR
F3.5 V2 ENGINE





jumpshot *mt*

WATERPROOF!



jumpshot *sc*

WATERPROOF!



jumpshot *st*

WATERPROOF!



COMING SOON
FLUX
FUZION
TO
jumpshot
see • brushless system

NEW
FOR 2016!

NEW
FOR 2016!

EVERY
jumpshot
HAS



ABSOLUTELY
EVERYTHING
INCLUDED!



THE NEW 2WD TRUCK PLATFORM FROM HPI!

For a fun and exciting 2WD monster truck, the new Jumpshot MT takes off-road fun to new levels! Designed around the durable Savage-style TVP (Twin Vertical Plate) chassis and featuring modular design, robust suspension and direct steering, the Jumpshot MT will let you drive for hours and hours for great big-air fun! The Jumpshot MT is a strong and reliable monster truck with a protected radio box, bottom-access battery box and huge all-terrain tires so you can get outside and have tons of fun!

#115116 - Jumpshot MT RTR w/2.4GHz

JUMPSHOT SC : SUPERCOOL SHORT COURSE ACTION!

The new Jumpshot SC is designed to look and perform just like a real rear-wheel drive short course racing truck. The center-balanced weight of the chassis means that driving and jumping is easy, and the wide closed-wheel look, combined with the multi-hole wheels and treaded off-road tires make it look awesome! With double-wishbone suspension, Savage-style TVP chassis and modular design, the Jumpshot is super tough and ready for off-road action!

#116103 - Jumpshot SC RTR w/2.4GHz

FANTASTIC STADIUM TRUCK FUN WITH THE JUMPSHOT ST!

If you're looking for a classic RC stadium truck, the new Jumpshot ST is the ideal choice for you! With its narrow body and extra-wide stance enhanced by the large off-road tires, the Jumpshot ST definitely looks the part and the Savage-style TVP chassis and center-balanced weight make sure it performs great too! With oil-filled shocks, double-wishbone suspension and RWD drivetrain, the action is fast and fun with the Jumpshot ST!

#116112 - Jumpshot ST RTR w/2.4GHz



E FIRESTORM 10T

WATERPROOF

ELECTRIC 2WD STADIUM TRUCK!



The perfect introduction to HPI off-road vehicles, the E-Firestorm 10T is a rear-wheel drive off-roader that's more than capable of getting around an RC track, field or back garden. With 8.4 volts of power from the battery included with the truck, you'll have plenty of power for jumping and the waterproof electronics let you have fun in the wet! The wide, long-stroke suspension is perfect for RC tracks and off-road terrain!

*Check local dealer for availability

#105845 RTR
E-Firestorm 10T

E FIRESTORM FLUX

WATERPROOF

STADIUM FLUX-TASTIC!



If you want even more power for on-demand wheelies and a massively fast top speed of over 77 mph (124km/h), you'll be wanting the E-Firestorm 10T Flux! A 4000KV HPI Flux motor is paired with a waterproof 3S LiPo-capable speed controller to give you jaw-dropping power for big-air stunts and long jumps! Using the same racing suspension as the standard E-Firestorm 10T means the Flux version is perfect for RC race tracks and just about any wide open dirt terrain!

77+
MPH

124+ km/h

**USING INCLUDED
SPEED PACK**

#112878 RTR E-Firestorm
10T Flux



FIRESTORM 10T

NITRO POWERED 2WD STADIUM TRUCK!



Stadium trucks and nitro power go together perfectly, and the Firestorm 10T is the ideal blend of smoke-spewing nitro-burning fun and easy to drive off-road madness! The powerful Nitro Star G3.0 engine sits in the middle of the aluminum chassis, giving the Firestorm perfect balance, and the 75cc fuel tanks lets you rip around a track or field for as long as you want. The off-road racing suspension is lifted straight from the electric versions, giving you great control and easy driving anywhere you take it!

#105866 RTR Firestorm 10T



**BONUS
SPEED PACK
INCLUDED**



G3.0

38+
MPH
60+ km/h



WATERPROOF
BLITZ FLUX

The Blitz short course racing truck took the RC world by storm – it's extra-tough construction, easy maintenance and speed potential were a revelation in RC design. Topped with a fantastic race truck body, chrome racing wheels and replica Maxxis Trepador tires, it not only performs great on the track, it looks great too!

Now fitted with waterproof electronics, it's the perfect companion for fun driving or racing in any weather, and you can get even more grins from your RC play day with the Blitz Flux, which is fitted with a 4000KV motor for instant wheelies, mega-fast speeds and huge stunts!



UP TO 3s LiPo POWER!

55+ MPH
88+ km/h



#109326 RTR Blitz Flux

WATERPROOF
BLITZ



#105832 RTR Blitz

BLITZ FLUX **BLITZ E-FIRESTORM FLUX** **E-FIRESTORM 10T** **FIRESTORM 10T**

OPTION PARTS

Check out the full range of Blitz, E-Firestorm and Firestorm 10T options : www.hpiracing.com

| | | | | |
|--|---|---|--|---|
| <p>104841 - ALU FRONT SUSPENSION ARM MOUNT (7075)</p> | <p>104867 - ALU FRONT SUSPENSION ARM MOUNT (3 DEGREE/ORANGE)</p> | <p>104891 - HIGH PERFORMANCE ALUMINUM STEERING RACK SET (BROWN ANODIZED)</p> | <p>103410 - ALU THREADED SHOCK SET (70-103MM)</p> | <p>109426 - E-FIRESTORM WHEELIE BAR</p> |
| <p>104898 - ALU REAR HUB CARRIER SET (0.5 DEGREE/BROWN)</p> | <p>103395 - ALU THREADED SHOCK SET (67-87MM)</p> | <p>104219 - PRECISION MACHINED HEATSINK MOTOR PLATE (BROWN ANODIZED)</p> | <p>100605 - UNIVERSAL DRIVE SHAFT SET (FIRESTORM/E-FIRESTORM)</p> | <p>103165 - UNIVERSAL DRIVE SHAFT SET (BLITZ/2PCS)</p> |

FIRESTORM 10T / E-FIRESTORM / E-FIRESTORM FLUX WHEELS & TIRES

| | | | | |
|---|---|--|---|---|
| <p>SCORCH 6-SPOKE WHEEL 3086 - GUN METAL / 3087 - CHROME / 3089 - BLACK CHROME / 3094 - BLACK</p> | <p>SPLIT 5 TRUCK WHEEL 3051 - BLACK / 3052 - CHROME</p> | <p>DIRT BONZ TIRES 4860 - DIRT BONZ JR S COMPOUND (2.2")</p> | <p>GT2 TIRES 105282 - GT2 TYRES D COMPOUND (2.2")</p> | <p>V GROOVE TIRES 4451 - TRUCK V GROOVE M COMPOUND (2.2")</p> |
| BLITZ / BLITZ FLUX WHEELS & TIRES | | | | |
| <p>MK.8 V2 WHEELS 106188 - BLACK 106189 - MATTE CHROME 106193 - WHITE</p> | <p>MK.10 V2 WHEELS 106199 - BLACK 106200 - MATTE CHROME 106201 - CHROME</p> | <p>MAXXIS TREPADOR TIRES 103804 - S COMPOUND</p> | <p>ATTK TIRES 103805 - D COMPOUND 103346 - D COMPOUND (BELTED) 103347 - S COMPOUND (BELTED)</p> | <p>INNER FOAMS 103334 - MEDIUM 103335 - SOFT</p> |



REAL STEER
PROPORTIONAL STEERING
FOR PRECISE CONTROL

**POCKET-SIZED
1/32 SCALE!**

Baja Q32

ACTUAL SIZE!

#114060 - Baja Q32 w/ 2.4GHz

MICRO-BAJA FUN FOR ALL!

The all-new Baja Q32 chassis is the smallest member of the HPI family, and it's the perfect way to get your RC fix on rainy days or when you're stuck in the office! Fitted with grippy foam tires and a direct rear-wheel drivetrain, it's light, nimble and FAST! At just 109mm (4.3") in length and 76mm (2.9") wide, it's ideal for racing in the smallest of spaces!

The Q32 Baja Buggy is fully painted, assembled and ready to drive right out of the box. All you need to supply is 4 x AA batteries for the small and cool-looking TF-60 2.4GHz radio transmitter, which acts as the car battery charger. Simply plug in the charging cord for a few minutes and away you go!



FORMULA Q32

NEW FOR 2016!

FORMULA RACING, Q-STYLE!

After taking the Q32 to stunt parks and the supercross style racing track, we took it to where you'd least expect: the formula racing circuit! With a ground-hugging, low-profile design and functional front & rear wings, the Formula Q32 is the perfect way to get your racing fix indoors! Racing on your dinner table or around the living room with style and glamour!

#116706 - Formula Q32 Blue Edition RTR
#116710 - Formula Q32 Red Edition RTR



REAL STEER
PROPORTIONAL STEERING
FOR PRECISE CONTROL



#115124 - Q32 D8T Tessmann Edition RTR

D8T TESSMANN EDITION Q32

TY'S TRUGGY - SHRUNK TO PERFECTION!

The World Champ's racing truggy, the HB D8T Tessmann Edition, is now available in a super-small Q32 size! Featuring an all-new racing truck body, dish wheels, low-profile tires and high-downforce rear wing, this is the perfect way to race your friends - driving around and jumping over your 'full size' HB D8T!

#115124 - Q32 D8T Tessmann Edition RTR



Qclub
SCAN FOR A WORLD OF Q32 FUN!
DOWNLOAD AND BUILD YOUR OWN Q32 STUNT PARK!

TINY 1/18 SCALE!

ABSOLUTELY EVERYTHING INCLUDED!



MINI RECON

The HPI Mini Recon is the perfect 1/18th scale fun package! Made from extremely tough composite material, the Mini Recon is nearly indestructible. Its powerful 370-size motor accelerates the Mini Recon to incredible top speeds and plenty of fun! The Mini Recon comes as a true RTR package with absolutely everything you need to get going, including: HPI 2.4GHz radio set, 7.2V NiMH battery, charger and even AA batteries for the transmitter! Everything you need to play with your friends is included in the box!

#105502 - RTR Mini Recon

*Check local dealer for availability



REAL STEER
PROPORTIONAL STEERING
FOR PRECISE CONTROL



TROPHY FLUX BUGGY

FANTASTICALLY FAST BRUSHLESS BUGGY FUN!

One of our most popular buggies, the Trophy is a race-bred car that you can take with confidence to the track, field or jumps and know you've got a winner! With a huge selection of racing features like long-stroke shocks, aluminum shock towers, triple gear diffs, thick steel turnbuckles and a high-torque steering servo, it can take on whatever you throw it at! Fitted with a 2.4GHz radio system and your choice of Flux 1965KV or race-ready 3.5cc nitro power, how you flavor your fun is up to you!

#107016 RTR Trophy Buggy Flux w/ 2.4GHz



UP TO 4s LiPo POWER!



#107012 RTR Trophy 3.5 Buggy w/ 2.4GHz



ALSO IN NITRO

TROPHY 4.6 TRUGGY



FULLY FEATURED TRUGGY RACER

Whether you want to race, rock out big-time stunts or just have a bit of fun, the Trophy Truggy is the ideal RC companion for those who like their action bigger, wider and wilder than the usual buggies you might find at your local RC area. Extra-wide suspension and super long shocks give the tall truggy tires the grip, with the help of full-time 4WD and triple gear differentials powered by either a 4.6cc nitro engine or an insane Flux 1965KV brushless motor to reach unbelievable speeds!

#107014 RTR Trophy Truggy 4.6 w/ 2.4GHz



NITRO STAR F4.6 ENGINE

OPTION PARTS



Check out the full range of Trophy options : www.hpiracing.com



#101785 - 5MM HEX WHEEL ADAPTERS TROPHY



#101142 - HARD DIFFERENTIAL GEAR SET



#101767 - STEERING ARMS 7075 TROPHY



#66213 - ALUM. REAR TOE-IN BLOCK 7075 (2 DEGREE)

#66214 - ALUM. REAR TOE-IN BLOCK 7075 (3 DEGREE)



#101768 - ALUM. SUSPENSION HOLDER (0 DEG) 6061

#101769 - ALUM. SUSPENSION HOLDER (3 DEG) 6061 TROPHY



#107018 RTR Trophy Truggy Flux w/ 2.4GHz

ALSO IN FLUX



BULLET 3.0

BLAST AWAY WITH THE UPDATED, BULLET!

Looking for a versatile, fun and durable truck you can take anywhere to blast around with your friends? The sleek and fast Bullet ST is the perfect RC companion! Ready for stunts, fast speeds and much more, it's a blend of extra-tough components, durable design and available with a super-fast 4000KV Flux motor or a screaming G3.0 nitro engine! With 4WD, 8 shocks and tough gear diffs, it's ready for the track, skate park, dirt jumps and plenty more!

#110660 RTR Bullet ST 3.0 w/ 2.4Ghz



G3.0



ALSO IN FLUX BULLET FLUX WATERPROOF

#110662 RTR Bullet ST Flux w/ 2.4Ghz

NEW LOOK



NEW LOOK



BULLET FLUX WATERPROOF



BLAST AWAY WITH WATERPROOF HPI FLUX POWER!

The Bullet MT has the looks of a rugged monster truck, and underneath it's just as tough and versatile as the Bullet ST! Just like its brother, it features tough gear diffs, big off-road tires on cool chrome wheels, 2 shocks on every corner and 4WD for traction anywhere you take it. It's also available with the HPI Flux 4000KV motor or the 2.2 horsepower Nitro Star G3.0 engine, so you can take your pick of power source!

#110663 RTR Bullet MT Flux w/ 2.4Ghz

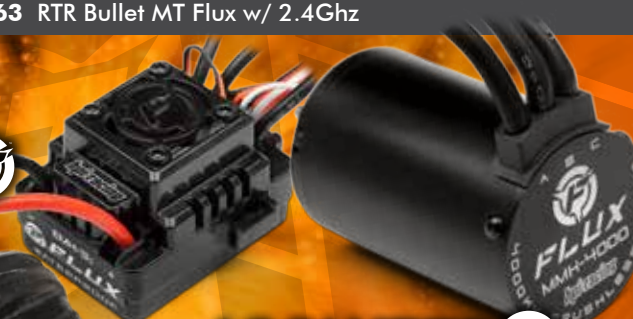

ALSO IN NITRO



BULLET 3.0

#110661 RTR Bullet MT 3.0

OPTION PARTS

Check out the full range of Bullet options : www.hpiracing.com



#108024 - ALUMINUM REAR BRACE (HARD ANODIZED)



#109921 - HD AXLE 5 x 40mm



#108078 - ALUMINUM KNUCKLE SET (HARD ANODIZED)



#101270 - BULLET 3.0 CVT SHAFT SET



CRAWLER KING

CONQUER THE HILL!

The Crawler King is the ultimate companion for hardcore off-trail rock climbing or muddy bog runs – with over 15cm (6”) of suspension travel and fitted with sticky HB Rover tires it can take whatever your off-road adventures can dish out! Waterproof protection ensures you won't get stuck carrying the Crawler King back to your campsite. Choose from the classic 1973 Ford Bronco painted in super-cool vintage colors or the all-new Ford Raptor with the latest pick-up truck style!



ABSOLUTELY EVERYTHING INCLUDED!



#113225 RTR Crawler King w/ Ford Bronco



OVER 6 INCHES OF SUSPENSION TRAVEL

ABSOLUTELY EVERYTHING INCLUDED!



COMING SOON
FLUX
FUZION
BBS • brushless system

WHEELY KING 4x4

OFF-ROAD WHEELY POPPIN' STUNTS!

Gear up for intense off-road and car-crushing action with the Wheely King 4x4! The Wheely King 4x4 is a true-to-scale monster truck that features full-time 4WD for maximum traction that allows it to go anywhere. From car-crushing stadium monster truck action to rock crawling in the mountains, the Wheely King 4x4 can do it all. And of course, awesome wheelie action is available with a pull of the trigger!

#106173 RTR Wheely King 4x4 Monster Truck

WATERPROOF!

FORD RAPTOR

#115118 RTR Crawler King w/ Ford Raptor



CRAWLER KING WATERPROOF!

LINE-UP SPOTTERS GUIDE

The whole HPI Racing Line-up at a glance



#109964 RTR BAJA 5SC w/ 2.4GHz



#112609 SAVAGE XL FLUX w/ 2.4GHz



#115967 RTR SAVAGE XS FLUX w/ VAUGHN GITGIN JR



#107018 RTR TROPHY TRUGGY FLUX



#109326 RTR BLITZ FLUX w/ 2.4GHz



#105866 RTR FIRESTORM 10T w/ 2.4GHz



#115484 KRAKEN BAJA 5B SX5 w/ 2.4GHz



#107684 RTR BAJA 5B FLUX w/ 2.4GHz



#109083 RTR SAVAGE X 4.6 w/ 2.4GHz



#101850 RTR VORZA FLUX HP w/ 2.4GHz



#107012 RTR TROPHY 3.5 BUGGY



#105832 RTR BLITZ w/ 2.4GHz



#115116 JUMPSHOT MT RTR w/ 2.4GHz



#115485 KRAKEN BAJA 5B TSK-b CLASS 1 w/ 2.4GHz



#109073 SAVAGE XL OCTANE w/ 2.4GHz



#106571 RTR SAVAGE XS FLUX w/ 2.4GHz



#106118 RTR D8S w/ 2.4GHz



#110661 RTR BULLET MT 3.0



#112878 RTR E-FIRESTORM 10T FLUX w/ 2.4GHz



#116103 JUMPSHOT SC RTR w/ 2.4GHz



#115123 BAJA 5R w/ 2.4GHz



#116050 SAVAGE XL 5.9 w/ 2.4GHz



#115125 RTR SAVAGE XS FLUX w/ FORD SVT RAPTOR



#115458 KEN BLOCK WRB 3.0



#110660 RTR BULLET ST 3.0



#105845 RTR E-FIRESTORM 10T w/ 2.4GHz



#116112 JUMPSHOT ST RTR w/ 2.4GHz



#115118 CRAWLER KING RTR FORD RAPTOR w/ 2.4GHz



#115990 RS4 SPORT 3 RTR HOONICORN w/ 2.4GHz



#114343 RS4 SPORT 3 RTR BMW M3 E30



#109299 RTR SPRINT 2 SPORT 1969 FORD MUSTANG RTR-X



#106154 RTR SPRINT 2 DRIFT w/ NISSAN 350Z



#109291 E10 DRIFT w/ DISCOUNT TIRE/FALKEN TIRE NISSAN S13



#105502 RTR MINI RECON



#113225 CRAWLER KING RTR FORD BRONCO w/ 2.4GHz



#115126 RS4 Sport 3 RTR MONSTER / NITTO MUSTANG RTR Spec 5



#112862 SPRINT 2 FLUX w/ BMW M3 GT



#106130 SPRINT 2 SPORT w/ NISSAN GT-R



#106149 RTR SPRINT 2 DRIFT w/ 2010 CHEVROLET CAMARO



#109494 E10 FORD MUSTANG RTR w/ FORD MUSTANG RTR



#114060 BAJA Q32 BUGGY



#106173 RTR WHEELY KING 4x4 w/ 2.4GHz



#115984 RS4 SPORT 3 RTR MUSTANG SPEC 5 w/ 2.4GHz



#108765 SPRINT 2 FLUX w/ 2010 CHEVROLET CAMARO



#106133 SPRINT 2 SPORT w/ 1969 CHEVROLET CAMARO



#112587 RTR NITRO RS4 3 DRIFT w/ DISCOUNT TIRE/FALKEN TIRE NISSAN S13



#115387 KEN BLOCK FORD FIESTA RX43 MICRO RS4



#115124 Q32 HB D8T TESSMANN EDITION TRUGGY



#114350 RS4 SPORT 3 FLUX RTR FALKEN TIRE PORSCHE 911 GT3 RSR



#114356 RS4 SPORT 3 DRIFT RTR SUBARU BRZ w/ 2.4GHz



#112710 SPRINT 2 FLUX w/ FORD MUSTANG GT-R



#108220 SPRINT 2 SPORT w/ 2012 FALKEN TIRE PORSCHE 911 GT3 RSR



#112619 RTR NITRO RS4 3 EVO+ w/ 1969 MUSTANG RTR-X



#112468 MICRO RS4 RTR w/ 1969 FORD MUSTANG RTR-X



#116706 FORMULA Q32 BLUE EDITION #116710 FORMULA Q32 RED EDITION

RS4 SPORT 3

FALKEN TIRE PORSCHE 911 GT3 RSR



WATERPROOF!

RS4 SPORT 3 FLUX

#114350 RS4 SPORT 3 FLUX RTR FALKEN TIRE PORSCHE 911 GT3 RSR



THE ICON IS BACK!

The RS4 Sport 3 is the all-new touring car chassis from HPI Racing! In development and refined for over a year, the RS4 Sport 3 features a completely sealed and highly efficient shaft drivetrain, coilover shock absorbers plus waterproof electronics. The fully contained drivetrain means there are no exposed gears, belts or drivetrain parts to get stuck with rocks or dirt. Finally, the RS4 Sport 3 is finished with realistic tires plus a licensed replica body and wheels for an authentic look that will grab the attention of all RC and motorsport enthusiasts!

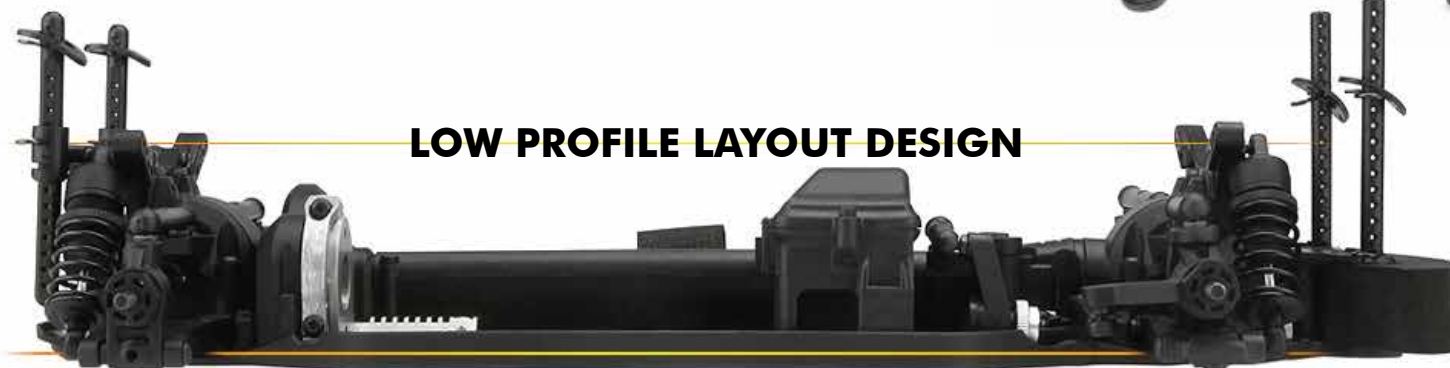

LOW PROFILE LAYOUT DESIGN

COMING SOON
FLUX FLUZION
gear • brushless system
 TO
RS4 SPORT 3



CUSTOMIZE YOUR LOOK

A huge variety of option bodies, wheels and tires from HPI lets you fully customize the style of your RS4 Sport 3 to suit your style.

RS4 SPORT 3

EASY ACCESS DIFFERENTIALS

Getting to the differentials for quick adjustments is a matter of removing just 4 screws - this allows you to pop out the diff and change the grease, check the gears or just give it a general service.



BOTTOM-ACCESS DRIVESHAFT

The central driveshaft that connects the front and rear differentials is easily accessed from underneath the chassis.

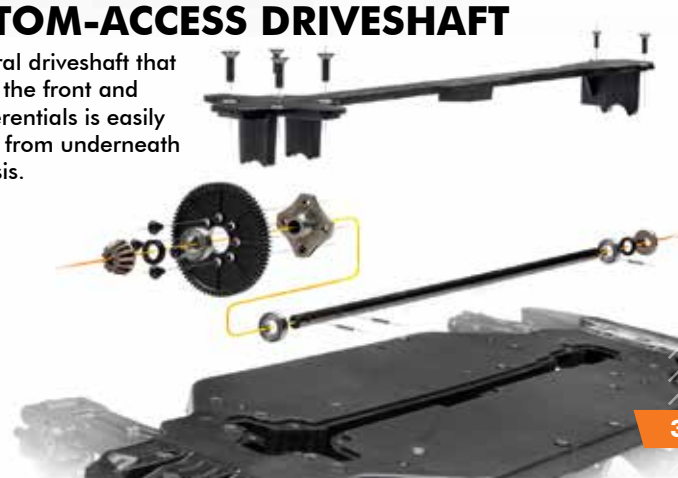



RS4 SPORT 3

WATERPROOF!



fifteen52



fifteen52 E30

The RS4 Sport 3 features the classic BMW M3 E30, fitted with replica white fifteen52 wheels wrapped with great-looking and grippy HPI street tires that let you roll in classic street style. The HPI Firebolt 15-turn motor and waterproof HPI speed controller are controlled by reliable 2.4GHz technology, and with the included batteries & charger it's ready to hit the streets right out of the box!

#114343 RS4 Sport 3 RTR BMW M3 E30

BMW M3 E30

RS4 SPORT 3 DRIFT

WATERPROOF!



LICENSED FALKEN DRIFT TIRES



RS4 SPORT 3 DRIFT ACTION!

The RS4 Sport 3 Drift is fitted with a Subaru BRZ body featuring HPI Racing x FATLACE livery, fitted with a set of Yoshihara Design Champion wheels and Falken Azenis RT615K HPI T-Drift tires for instant easy drift action! With a 15-turn motor, waterproof speed controller and 2.4GHz tech installed, it's never been easier to get drifting, fast! The RS4 Sport 3 Drift also includes batteries and charger to get you on the streets as soon as you open the box!

#114356 RS4 Sport 3 Drift RTR SUBARU BRZ

SUBARU BRZ

RS4 SPORT 3 FLUX

WATERPROOF!



70+ MPH
113+ km/h

UP TO 3S LiPo POWER!



EMH-3S
brushless electronic speed controller



MMH-4000V
brushless motor



FALKEN TIRE PORSCHE 911 GT3 RSR

RS4 SPORT 3 WITH FLUX POWER!

The RS4 Sport 3 Flux features the #17 Porsche 911 GT3 RSR of the Falken Tire racing team, with its 'urban camo' and stylized shark-mouth adding to the head-turning style. Finishing the race car look are a set of our extra-wide (31mm and 35mm) replica BBS wheels fitted with matching slick racing tires! Propelling the RS4 Sport 3 Flux to speeds over 70mph (113km/h) is the Flux MMH-4000KV motor, controlled by the waterproof Flux EMH-3S LiPo-ready speed controller. All you need to do is add your own 2S or 3S LiPo battery.

#114350 RS4 Sport 3 Flux RTR Falken Tire Porsche 911 GT3 RSR

OPTION PARTS



Check out the full range of Sport 3 options : www.hpiracing.com

#114433 - SHOCK TOWER (FRONT/CARBON FIBER)



#114434 - SHOCK TOWER (REAR/CARBON FIBER)

#114437 - UNIVERSAL DRIVE SHAFT SET



#114436 - 40T SPOOL SET

#TBC - ANODIZED ALUMINUM FRONT PIVOT BLOCK

#TBC - ANODIZED ALUMINUM REAR PIVOT BLOCK

#TBC - MACHINED ANODIZED ALUMINUM MOTOR MOUNT

#114432 - CENTER DRIVE SHAFT COVER SET

#105409 - HPI D-BOX 2 ADJUSTABLE STABILITY CONTROL SYSTEM



#114435 - ALUMINUM SHOCK SET (4PCS)





WANT TO DRIVE THE HOONICORN?

One-of-a-kind styling. Based on a 1965 Ford Mustang body. Roush Yates V8. 410 cubic inches. 845 bhp. All-wheel drive. Inspired by WRC, DTM and muscle cars. Built by Ford Mustang specialists RTR. Driven by Block. Official replica by HPI Racing.

#115990 RS4 Sport 3 1965 Ford Mustang Hoonicorn RTR



SCAN THE QR CODE TO SEE THE HOONICORN IN ACTION IN GYMKHANA 7





RS4 SPORT 3 WATERPROOF

VAUGHN GITTIN JR



2015 FORD MUSTANG RTR SPEC 5

VGJR RTR STREET DRIFT

The newest Ford Mustang has been styled by Vaughn's RTR tuning team to become the awesome Ford Mustang RTR Spec 5, and you can get a replica of the car on the fabulous RS4 Sport 3 chassis! The kit includes green RTR by HRE Tech 7 wheels wrapped with great-looking tires and has all the features of the new RS4 Sport 3!

#115126 RS4 Sport 3 RTR 2015 Ford Mustang RTR Spec 5



MONSTER ENERGY NITTO TIRE FORD MUSTANG RTR

VGJR FORMULA DRIFT 2016

Available on the new RS4 Sport 3 chassis, the awesome Monster Energy Nitto Tire Ford Mustang RTR driven by Vaughn in the Formula Drift is definitely the coolest pony car on the pro drift circuit! There's no other way to get a replica of this amazing car, and it's fitted with matching replica wheels and tires to give it the authentic pro look!

#115984 RS4 Sport 3 RTR Monster / Nitto Mustang RTR Spec 5



RTR-X

ONE OF A KIND!

The RTR-X project is a fully-functional Street/Drift machine. Balancing 5.0 liters of tire-slaying American horsepower with vintage American and drift-culture inspired design influences, Vaughn and his team incorporated state-of-the-art technology while retaining a nostalgic feel into this vision for the 69' Mustang's timeless body. The RTR-X was designed and built from the ground up to be driven hard; the RTR-X is NOT a trailer queen.

Vaughn Gittin Jr, the brains behind the RTR-X, is the only one who can actually sit in the car to drive it for real, however YOU can drive away in the RTR-X simply by getting yourself an officially licensed nitro or electric-powered replica!



DRIFT TIRES and GRIP TIRES INCLUDED!



nitro RS4 3 evo+

#112619 RTR Nitro RS4 3 Evo+ w/ 1969 Ford Mustang RTR-X Body



WATERPROOF Sprint 2 Sport

#109299 RTR Sprint 2 Sport w/ 1969 Ford Mustang RTR-X Body



MICRO RS4

#112468 Micro RS4 RTR w/ 1969 Ford Mustang RTR-X Body





Sprint 2 Sport

RETRO STREET STYLE!

The HPI Sprint 2 Sport is the perfect car for anyone wanting a high-quality, quick and tough RC car for the street or track! The Sprint 2 Sport is loaded with fabulous features designed for durability & ease of maintenance.

#106133 - RTR Sprint 2 Sport w/ Painted 1969 Chevrolet Camaro body



'69 CHEVY

WATERPROOF!

ALSO AVAILABLE :

#106130 - RTR Sprint 2 Sport w/ Painted Nissan GT-R body



Sprint 2 FLUX

WATERPROOF!

OUR FASTEST SPRINT 2!

The RTR Sprint 2 Flux is the easiest way to jump right into the wild and fast world of brushless street car fun! The Sprint 2 chassis is a fantastic way to get started with touring cars and street racing, because it features a completely pre-assembled race car chassis that's ready for loads of action!

#112862 - RTR Sprint 2 Flux w/ BMW M3 GTS Orange



53+ MPH

85+ km/h

ALSO AVAILABLE :



#112710 - RTR Sprint 2 Flux w/ painted Ford Mustang GT-R body



#108765 - RTR Sprint 2 Flux w/ painted 2010 Chevrolet Camaro body



BMW M3 GTS



Sprint 2 DRIFT

FUN, FAST AND STYLISH!

If you've got the burning desire to bust out some tire-shredding drift action in a wild and exciting package, then look no further, the HPI Sprint 2 Drift is the car for you! The Sprint 2 Drift is the drift version of the Sprint 2 Sport and has most of the same features: composite double-deck chassis, dual belt drive, maintenance-free gear diffs, waterproof electronics and hassle-free 2.4GHz control.

#106154 - RTR Sprint 2 Drift w/ painted Nissan 350Z body



WATERPROOF!



LICENSED FALKEN DRIFT TIRES

ALSO AVAILABLE :



#106149 - RTR Sprint 2 Drift w/ painted 2010 Chevrolet Camaro body



OPTION PARTS



#86198 - UNIVERSAL DOGBONE 6 X 70mm



#86042 - FRONT ONE-WAY DIFF 32T



#86040 - BALL DIFFERENTIAL SET 32T



#72036 - ALU HEX HUB CLAMP TYPE



#105409 - HPI D-BOX 2



NISSAN 350Z



CUSTOMIZE YOUR RIDE!

RS4 **SPORT 3** Sprint 2

nitro RS4 **E10**

HERE'S JUST A SMALL SELECTION OF THE 1000'S OF HPI COMBINATIONS AVAILABLE TO CUSTOMIZE YOUR RIDE!

AMERICAN MUSCLE



#7494 - 1968 Chevrolet® Camaro Body (200mm/210mm)

#17531 - 1969 Chevrolet® Camaro Z28® Body (200mm)

#17508 - 1965 Shelby GT-350 Body (200mm/WB255mm)

#104926 - 1966 Ford Mustang GT Coupe Body (200mm)



#105106 - 1970 Dodge Challenger Body (200mm)

#17526 - 1967 Chevrolet® Corvette® Body (200mm)

#17546 - 1970 Ford Mustang Boss 302 Body (200mm)

#17519 - 1966 Ford Mustang Gt Body (200mm)



#107201 - 1978 Pontiac Firebird Body (200mm)

#109930 - 1969 Ford Mustang RTR-X Body (200mm)

#17543 - 2010 Chevrolet® Camaro Body (200mm)

#106108 - 2011 Ford Mustang RTR Body (200mm)

EURO CLASSICS



#17540 - BMW M3 E30 Body (200mm)

#17548 - BMW M3 GT2 (E92) Body (200mm)

#108370 - 2012 Porsche 911 GT3 RSR Body (206mm/210mm)

#17541 - Porsche 911 GT3 RS Body (200mm)

JDM TUNERS



#17209 - Toyota Trueno AE86 Body (190mm)

#17214 - Toyota Levin AE86 Body (190mm)

#17530 - Nissan Silvia Body (S15/200mm)

#17524 - Vertex Ridge Toyota Soarer Body (200mm)



#17525 - Prova HPI Impreza Clear Body (200mm)

#17545 - Mitsubishi Lancer Evolution X Body (200mm)

#17539 - Toyota Supra Aero Body (200mm)

#17538 - Nissan GT-R (R35) Body (200mm)



VINTAGE WHEELS



Vintage 8 Spoke
 #3805 - White 26mm
 #3810 - White 31mm
 #3806 - Black 26mm
 #3811 - Black 31mm
 #3808 - Matte Chrome 26mm
 #3812 - Matte Chrome 31mm
 #3809 - Gunmetal 26mm
 #3813 - Gunmetal 31mm



Vintage 5 Spoke
 #3815 - Matte Chrome 26mm
 #3820 - Matte Chrome 31mm
 #3816 - Black 26mm
 #3821 - Black 31mm
 #3817 - Chrome 26mm
 #3822 - Chrome 31mm



Vintage CC Type
 #33472 - Chrome 26mm
 #33473 - Chrome 31mm



Vintage Stock Car
 #3854 - Black 26mm
 #3858 - Black 31mm
 #3855 - White 26mm
 #3859 - White 31mm
 #3856 - Gunmetal 26mm
 #3860 - Gunmetal 31mm
 #3857 - Chrome 26mm
 #3861 - Chrome 31mm



Check out the full range of HPI wheels and tires : www.hpiracing.com

VINTAGE TIRES



Vintage Racing Tire
 #4793 - 26mm D Compound
 #4797 - 31mm D Compound



Vintage Slick Racing Tire
 #4791 - 26mm
 #4792 - 31mm



Vintage Performance Tire
 #102993 - 26mm
 #102994 - 31mm



Vintage Drift Tire
 #4794 - 26mm
 #4798 - 31mm

STREET PERFORMANCE WHEELS



fifteen52 TurboMac 26mm
 #114637 - White 6mm offset
 #114638 - Black 6mm offset



RTR Wheel 26mm
 #112812 - Gunmetal 6mm offset
 #112811 - Green 6mm offset



DY-Champion 26mm
 #111276 - Silver 6mm offset
 #114636 - Silver 9mm offset
 #113090 - Bronze 6mm offset



FIVE:AD 26mm
 #107140 - Gunmetal 6mm offset



HRE C106 26mm
 #112813 - White 6mm offset



TE37 26mm
 #3835 - White 0mm offset
 #3836 - Black 0mm offset
 #3837 - Chrome 0mm offset
 #3838 - Bronze 0mm offset
 #3840 - White 3mm offset
 #3841 - Black 3mm offset
 #3842 - Chrome 3mm offset
 #3843 - Bronze 3mm offset
 #3845 - White 6mm offset
 #3846 - Black 6mm offset
 #3847 - Chrome 6mm offset
 #3848 - Bronze 6mm offset



Work Meister S1 26mm wheel Chrome
 #3591 - (3mm offset)
 #3592 - (6mm offset)
 #3593 - (9mm offset)



WORK XSA 02C 26mm
 #3297 - 3mm offset
 #3298 - 6mm offset
 #3299 - 9mm offset



BBS Spoke
 #109156 - Black 31mm
 #109155 - Black 34mm

STREET PERFORMANCE TIRES



X-PATTERN RADIAL 26mm
 #4790 - D Compound



Spec Grip Tire
 #113717 - 26mm



FALKEN AZENIS SLICK
 #109158 - 31mm



FALKEN AZENIS SLICK
 #109157 - 34mm



T-Grip Tire
 #4405 - 26mm

DRIFT TIRES



#4406 - T-Drift Tire 26mm



#4425 - Falken Azenis RT615 T-Drift Tire 26mm



#4421 - Advan Neova AD07 T-Drift Tire 26mm



#4422 - Proxes R1R T-Drift Tire 26mm



#4423 - Potenza RE-01R T-Drift Tire 26mm



#4424 - Direzza Sport Z1 T-Drift Tire 26mm



#4402 - Super Drift Tire 26mm Radial



FLUX BRUSHLESS MOTORS



#104923 - FLUX ALPHASTAR 2350Kv BRUSHLESS MOTOR
2350 rpm/volt /Use with FLUX Q-BASE ESC

#100685 - FLUX TORK 2200Kv BRUSHLESS MOTOR
2200 rpm/volt /Use with FLUX BLUR ESC



#101713 - FLUX SCREAM 1965 Kv BRUSHLESS MOTOR
1965 rpm/volt /Use with FLUX RAGE ESC



#106766 - FLUX VEKTOR 5900Kv
#106628 - FLUX VEKTOR 4800Kv
#106768 - FLUX VEKTOR 4000Kv
Use with FLUX Vapor ESC



#112850 - FLUX MMH-4000Kv BRUSHLESS MOTOR
Use with FLUX EMH-3S ESC



#101731 - FLUX PRO 10.5T COMPETITION BRUSHLESS MOTOR
#101732 - FLUX PRO 13.5T COMPETITION BRUSHLESS MOTOR
#101734 - FLUX PRO 21.5T COMPETITION BRUSHLESS MOTOR

FLUX BRUSHLESS ESCs



#113126 - ELC-6S WATERPROOF ESC
1/8th scale waterproof sensorless brushless speed control

#104924 - FLUX Q-BASE BRUSHLESS ESC
Compatible with sensed and sensorless brushless motor



#101712 - FLUX RAGE BRUSHLESS ESC
Use with FLUX SCREAM brushless motor



#106767 - FLUX VAPOR PRO WATER-PROOF ESC
Use with Flux Vektor and Flux Warp motors



#112851 - FLUX EMH-3S BRUSHLESS ESC
Use with FLUX MMH-4000Kv brushless motor



#106627 - FLUX VAPOR WATERPROOF ESC
Use with Flux Vektor and Flux Warp motors



#101830 - FLUX PRO COMPETITION ESC
2S-3S LiPo sensed esc. 3.5T motor limit. Fully programmable requires use of #101856

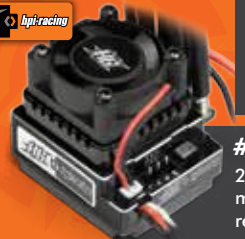

#101856 - FLUX RELOAD ESC PROGRAM BOX V2
Allows programming & updating of compatible flux escs



#100573 - CASTLE LINK USB PROGRAMMING KIT
Allows programming and updating of compatible FLUX ESCs through Windows PC



NITRO ENGINES



#15250 - NITRO STAR K5.9 ENGINE WITH PULLSTART
5.9cc/ABC/3 Port/9.5mm Composite Slide Carb./Aluminum Heat Sink Head (Gunmetal)/Rear Exhaust/R5 Glow Plug



#111595 - NITRO STAR F4.6 V2 ENGINE WITH PULLSTART
4.6cc/Composite Slide Carb./Rear Exhaust/Pullstart/Includes Air Cleaner and Glow Plug (R5)

#111600 - NITRO STAR F3.5 V2 ENGINE WITH PULLSTART
3.5cc/Composite Slide Carb./Rear Exhaust/Pullstart/Includes Air Cleaner and Glow Plug (R5)

#110610 - NITRO STAR F3.5 PRO 2013 REAR EXHAUST
3.48cc/Composite Slide Carb./Rear Exhaust/Max RPM: 45000/Bore: 16.20mm



3.4 HP RACE LEGAL



#15107 - NITRO STAR T3.0 ENGINE WITH PULLSTART
6.5mm Rotary Carb./ABC/Standard Shaft/Side Exhaust/Heatsink Head/Black Crank Case

2.5 HP RACE LEGAL



#15105 - NITRO STAR G3.0 ENGINE W/ PULLSTART

#101310 - G3.0 ENGINE SLIDE CARB W/ PULL START

#107824 - NITRO STAR G3.0 HO ENGINE W/ PULLSTART
High output nitro engine/7mm Slide Carb./ABC/SG Shaft/Side Exhaust



GAS ENGINES



#111390 - OCTANE 15CC ENGINE
15cc Gasoline Engine/with #109054 Air Filter
Air-Cooled 2-Stroke Engine/Bore x Stroke: 27.7x24.8mm/Max Power: 2.7PS /14,000 RPM/Max Torque: 1.4N.m /13,000 RPM/ Carb: WT668B custom/Plug: CM6

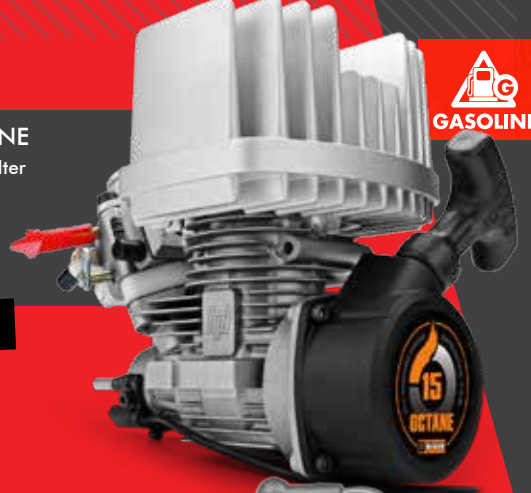

2.7hp 15cc 2-stroke

Fuelie GASOLINE ENGINE



#107936 - FUELIE K23 ENGINE
23cc Gasoline Engine/with #15411 Air Filter









#107940 - FUELIE K26 ENGINE
26cc Gasoline Engine (1mm piston ring) with #15411 Air Filter



Check out the full range of nitro and gasoline engines : www.hpiracing.com







Baja

The iconic large scale desert racing chassis that changed 1/5th scale RC forever

| | PART NO. | SCALE | POWER | DRIVE | D/TYPE | SURFACE | DIMENSIONS | WEIGHT |
|--|--------------------------------------|---------|---------------------|-------|--------|----------|---|----------------------|
|  | Baja 5B Kraken SX5 Sidewinder page 4 | #115484 | 1/5TH GAS | 2WD | RWD | OFF-ROAD | LENGTH : 900mm WIDTH : 480mm HEIGHT : 320mm W/B : 570mm | 12.6 KG WITHOUT FUEL |
|  | Baja 5B Kraken TSK-b Class 1 page 5 | #115485 | 1/5TH GAS | 2WD | RWD | OFF-ROAD | LENGTH : 900mm WIDTH : 460mm HEIGHT : 320mm W/B : 570mm | 12.6 KG WITHOUT FUEL |
|  | Baja Flux page 6 | #107684 | 1/5TH ELECTRIC FLUX | 2WD | RWD | OFF-ROAD | LENGTH : 817mm WIDTH : 480mm HEIGHT : 255mm W/B : 570mm | 9.6 KG WITHOUT FUEL |
|  | Baja 5B SS page 6 | #112457 | 1/5TH GAS | 2WD | RWD | OFF-ROAD | LENGTH : 817mm WIDTH : 480mm HEIGHT : 255mm W/B : 570mm | 9.6 KG WITHOUT FUEL |
|  | Baja 5B page 6 | #110190 | 1/5TH GAS | 2WD | RWD | OFF-ROAD | LENGTH : 817mm WIDTH : 480mm HEIGHT : 255mm W/B : 570mm | 9.6 KG WITHOUT FUEL |
|  | Baja 5SC page 6 | #109964 | 1/5TH GAS | 2WD | RWD | OFF-ROAD | LENGTH : 900mm WIDTH : 460mm HEIGHT : 320mm W/B : 570mm | 12.6 KG WITHOUT FUEL |
|  | Baja 5T page 6 | #110185 | 1/5TH GAS | 2WD | RWD | OFF-ROAD | LENGTH : 900mm WIDTH : 460mm HEIGHT : 320mm W/B : 570mm | 12.6 KG WITHOUT FUEL |
|  | Baja 5R page 3 | #115123 | 1/5TH GAS | 2WD | RWD | ON-ROAD | LENGTH : 1040mm WIDTH : 510mm HEIGHT : 280mm W/B : 570mm | 12.6 KG WITHOUT FUEL |



SAVAGE

The legendary monster truck that still offers groundbreaking toughness and fun – ideal for serious, heavy-duty bashing

| | | | | | | | | |
|---|--------------------------|---------|---------------------|-----|-------|----------|--|----------------------------------|
|  | Savage XL Octane page 8 | #109073 | 1/8TH GAS | 4WD | SHAFT | OFF-ROAD | LENGTH : 585mm WIDTH : 445mm HEIGHT : 265mm W/B : 395mm | 7.0 KG WITHOUT FUEL & BATTERIES |
|  | Savage XL page 8 | #116050 | 1/8TH NITRO | 4WD | SHAFT | OFF-ROAD | LENGTH : 585mm WIDTH : 445mm HEIGHT : 265mm W/B : 395mm | 5.4 KG WITHOUT FUEL & BATTERIES |
|  | Savage X 4.6 page 9 | #109083 | 1/8TH NITRO | 4WD | SHAFT | OFF-ROAD | LENGTH : 534mm WIDTH : 427mm HEIGHT : 254mm W/B : 337mm | 4.95 KG WITHOUT FUEL & BATTERIES |
|  | Savage X SS | #861 | 1/8TH NITRO | 4WD | SHAFT | OFF-ROAD | LENGTH : 534mm WIDTH : 427mm HEIGHT : 254mm W/B : 337mm | 4.95 KG WITHOUT FUEL & BATTERIES |
|  | Savage XL Flux page 8 | #112609 | 1/8TH ELECTRIC FLUX | 4WD | SHAFT | OFF-ROAD | LENGTH : 585mm WIDTH : 445mm HEIGHT : 265mm W/B : 395mm | 5.2 KG WITHOUT BATTERIES |
|  | Savage XS Raptor page 11 | #115125 | MINI ELECTRIC FLUX | 4WD | SHAFT | OFF-ROAD | LENGTH : 360mm WIDTH : 280mm HEIGHT : 160mm W/B : 225mm | 2.15 KG WITHOUT BATTERIES |
|  | Savage XS VG Jr page 10 | #115967 | MINI ELECTRIC FLUX | 4WD | SHAFT | OFF-ROAD | LENGTH : 360mm WIDTH : 280mm HEIGHT : 160mm W/B : 225mm | 2.15 KG WITHOUT BATTERIES |

VORZA

The record-setting 1/8th scale electric buggy that set the world alight with its speed and durability – perfect for racers and bashers

| | | | | | | | | |
|---|-------------------------------------|---------|---------------------|-----|-------|----------|--|---------------------------------|
|  | Vorza Flux HP page 16 | #101850 | 1/8TH ELECTRIC FLUX | 4WD | SHAFT | OFF-ROAD | LENGTH : 508mm WIDTH : 205mm HEIGHT : 178mm W/B : 325mm | 3.45 KG WITHOUT BATTERIES |
|  | Ken Block 2015 CRC WR8 Flux page 12 | #115383 | 1/8TH ELECTRIC FLUX | 4WD | SHAFT | OFF-ROAD | LENGTH : 485mm WIDTH : 227mm HEIGHT : 172mm W/B : 300mm | 2.25 KG WITHOUT BATTERIES |
|  | Ken Block 2015 CRC WR8 3.0 page 12 | #115458 | 1/8TH NITRO | 4WD | SHAFT | OFF-ROAD | LENGTH : 485mm WIDTH : 227mm HEIGHT : 172mm W/B : 300mm | 2.3 KG WITHOUT FUEL & BATTERIES |





D8S

The ready-to-drive version of the World Champion D812, this nitro-powered 1/8th scale buggy is a great intro to buggy racing

| | | | | | | | | |
|---|-----------------|---------|-------------|-----|-------|----------|--|---------------------------------|
|  | RTR D8S page 16 | #106118 | 1/8TH NITRO | 4WD | SHAFT | OFF-ROAD | LENGTH : 500mm WIDTH : 305mm HEIGHT : 179mm W/B : 320mm | 3.4 KG WITHOUT FUEL & BATTERIES |
|---|-----------------|---------|-------------|-----|-------|----------|--|---------------------------------|

TROPHY

An extremely popular range of tough and versatile 1/8th scale RTR buggies and truggies, in electric and nitro versions

| | | | | | | | | |
|---|----------------------------|---------|---------------------|-----|-------|----------|--|----------------------------------|
|  | Trophy Truggy 4.6 page 25 | #107014 | 1/8TH NITRO | 4WD | SHAFT | OFF-ROAD | LENGTH : 580mm WIDTH : 405mm HEIGHT : 180mm W/B : 365mm | 4.3 KG WITHOUT FUEL & BATTERIES |
|  | Trophy Buggy 3.5 page 25 | #107012 | 1/8TH NITRO | 4WD | SHAFT | OFF-ROAD | LENGTH : 500mm WIDTH : 305mm HEIGHT : 179mm W/B : 320mm | 3.45 KG WITHOUT FUEL & BATTERIES |
|  | Trophy Truggy Flux page 24 | #107018 | 1/8TH ELECTRIC FLUX | 4WD | SHAFT | OFF-ROAD | LENGTH : 580mm WIDTH : 405mm HEIGHT : 180mm W/B : 365mm | 4.15 KG WITHOUT BATTERIES |
|  | Trophy Buggy Flux page 24 | #107016 | 1/8TH ELECTRIC FLUX | 4WD | SHAFT | OFF-ROAD | LENGTH : 500mm WIDTH : 305mm HEIGHT : 179mm W/B : 320mm | 3.15 KG WITHOUT BATTERIES |





PULSE 46

A versatile and durable 1/8th scale nitro racing buggy that's a great racer or park basher

| | | | | | | | | |
|---|---------------|---------|-------------|-----|-------|----------|--|----------------------------------|
|  | RTR Pulse 4.6 | #107020 | 1/8TH NITRO | 4WD | SHAFT | OFF-ROAD | LENGTH : 500mm WIDTH : 350mm HEIGHT : 179mm W/B : 320mm | 3.25 KG WITHOUT FUEL & BATTERIES |
|---|---------------|---------|-------------|-----|-------|----------|--|----------------------------------|



BULLET

A massively popular range of fun and durable 1/10th scale RTR trucks that are an ideal introduction to HPI vehicles

| | | | | | | | | |
|---|----------------------------|---------|----------------------|-----|-------|----------|--|---------------------------------|
|  | RTR Bullet ST 3.0 page 28 | #110660 | 1/10TH NITRO | 4WD | SHAFT | OFF-ROAD | LENGTH : 417mm WIDTH : 336mm HEIGHT : 160mm W/B : 272mm | 2.7 KG WITHOUT FUEL & BATTERIES |
|  | RTR Bullet MT 3.0 page 29 | #110661 | 1/10TH NITRO | 4WD | SHAFT | OFF-ROAD | LENGTH : 417mm WIDTH : 336mm HEIGHT : 160mm W/B : 272mm | 2.7 KG WITHOUT FUEL & BATTERIES |
|  | RTR Bullet ST Flux page 28 | #110662 | 1/10TH ELECTRIC FLUX | 4WD | SHAFT | OFF-ROAD | LENGTH : 417mm WIDTH : 336mm HEIGHT : 160mm W/B : 272mm | 2.55 KG WITHOUT BATTERIES |
|  | RTR Bullet MT Flux page 29 | #110663 | 1/10TH ELECTRIC FLUX | 4WD | SHAFT | OFF-ROAD | LENGTH : 417mm WIDTH : 336mm HEIGHT : 160mm W/B : 272mm | 2.55 KG WITHOUT BATTERIES |



BLITZ

This ever-popular 1/10th scale RTR short course style truck is extremely fun to race or drive with friends

| | PART NO. | SCALE | POWER | DRIVE | D/TYPE | SURFACE | DIMENSIONS | WEIGHT |
|---|---------------------------|---------|-------------------------|-------|--------|----------|--|------------------------------|
|  | RTR Blitz page 22 | #105832 | 1/10TH ELECTRIC | 2WD | RWD | OFF-ROAD | LENGTH : 548mm WIDTH : 296mm HEIGHT : 200mm W/B : 329mm | 2 KG WITHOUT BATTERIES |
|  | RTR Blitz Flux page 22 | #109326 | 1/10TH ELECTRIC FLUX | 2WD | RWD | OFF-ROAD | LENGTH : 548mm WIDTH : 296mm HEIGHT : 200mm W/B : 329mm | 2 KG WITHOUT BATTERIES |



FIRESTORM 10T

Fast and strong, the Firestorm 10T family of 1/10th scale trucks features one nitro-powered and 2 different electric-powered trucks

| | | | | | | | | |
|---|---------------------------------|---------|-------------------------|-----|-----|----------|--|---|
|  | FIRESTORM 10T page 21 | #105866 | 1/10TH NITRO | 2WD | RWD | OFF-ROAD | LENGTH : 425mm WIDTH : 325mm HEIGHT : 165mm W/B : 292mm | 2.05 KG WITHOUT FUEL & BATTERIES |
|  | E-FIRESTORM 10T page 20 | #105845 | 1/10TH ELECTRIC | 2WD | RWD | OFF-ROAD | LENGTH : 425mm WIDTH : 325mm HEIGHT : 165mm W/B : 292mm | 1.65 KG WITHOUT BATTERIES |
|  | E-FIRESTORM 10T FLUX page 20 | #112878 | 1/10TH ELECTRIC FLUX | 2WD | RWD | OFF-ROAD | LENGTH : 425mm WIDTH : 325mm HEIGHT : 165mm W/B : 292mm | 1.65 KG WITHOUT BATTERIES |







Jumpshot

The perfect first RC truck, the Jumpshot is tough, simple and quick, featuring easy battery swapping and 2WD fun

| | | | | | | | | |
|---|------------------------|---------|-----------------|-----|-----|----------|--|---|
|  | JUMPSHOT MT page 16 | #115116 | 1/10TH ELECTRIC | 2WD | RWD | OFF-ROAD | LENGTH : 410mm WIDTH : 330mm HEIGHT : 200mm W/B : 270mm | 1.85 KG WITHOUT FUEL & BATTERIES |
|  | JUMPSHOT SC page 17 | #116103 | 1/10TH ELECTRIC | 2WD | RWD | OFF-ROAD | LENGTH : 548mm WIDTH : 296mm HEIGHT : 200mm W/B : 329mm | 1.85 KG WITHOUT BATTERIES |
|  | JUMPSHOT ST page 17 | #116112 | 1/10TH ELECTRIC | 2WD | RWD | OFF-ROAD | LENGTH : 548mm WIDTH : 296mm HEIGHT : 200mm W/B : 329mm | 1.85 KG WITHOUT BATTERIES |









RS4 SPORT 3

With an enclosed shaft drivetrain, 4-wheel drive and full track tuning abilities, the Sport 3 is the ideal car for the street or track

| | | | | | | | | |
|---|--|---------|-----------------|-----|-------|---------|--|---------------------------------|
|  | SPORT 3 RTR W/ BMW M3 E30 page 36 | #114343 | 1/10TH ELECTRIC | 4WD | SHAFT | ON-ROAD | LENGTH : 431mm WIDTH : 200mm HEIGHT : 140mm W/B : 254mm | 1.3 KG WITHOUT BATTERIES |
|  | SPORT 3 RTR W/ FORD MUSTANG RTR SPEC 5 page 40 | #115126 | 1/10TH ELECTRIC | 4WD | SHAFT | ON-ROAD | LENGTH : 450mm WIDTH : 200mm HEIGHT : 125mm W/B : 254mm | 1.3 KG WITHOUT BATTERIES |
|  | SPORT 3 RTR W/ FORD MUSTANG Vaughn Gittin Jr Drift Version page 40 | #115984 | 1/10TH ELECTRIC | 4WD | SHAFT | ON-ROAD | LENGTH : 450mm WIDTH : 200mm HEIGHT : 125mm W/B : 254mm | 1.3 KG WITHOUT BATTERIES |
|  | SPORT 3 DRIFT RTR W/ SUBARU BRZ page 36 | #114356 | 1/10TH ELECTRIC | 4WD | SHAFT | ON-ROAD | LENGTH : 450mm WIDTH : 205mm HEIGHT : 125mm W/B : 254mm | 1.3 KG WITHOUT BATTERIES |
|  | SPORT 3 FLUX RTR W/ Falken Tire Porsche 911 GT3 RSR page 37 | #114350 | 1/10TH ELECTRIC | 4WD | SHAFT | ON-ROAD | LENGTH : 480mm WIDTH : 210mm HEIGHT : 135mm W/B : 254mm | 1.45 KG WITHOUT BATTERIES |
|  | SPORT 3 RTR W/ Ken Block's 1965 Ford Mustang Hoonicorn RTR page 36 | #115990 | 1/10TH ELECTRIC | 4WD | SHAFT | ON-ROAD | LENGTH : 450mm WIDTH : 210mm HEIGHT : 125mm W/B : 254mm | 1.3 KG WITHOUT BATTERIES |

Sprint 2

This hugely versatile touring car chassis can be a muscle car, exotic racer, street machine or drifter

| | | | | | | | | |
|---|--|---------|-------------------------|-----|------|---------|--|---------------------------------|
|  | RTR SPRINT 2 SPORT W/ NISSAN GT-R (R35) BODY page 46 | #106130 | 1/10TH ELECTRIC | 4WD | BELT | ON-ROAD | LENGTH : 431mm WIDTH : 200mm HEIGHT : 127mm W/B : 254mm | 1.25 KG WITHOUT BATTERIES |
|  | SPRINT 2 SPORT RTR W/ 1969 CHEVROLET CAMARO Z28 page 46 | #106133 | 1/10TH ELECTRIC | 4WD | BELT | ON-ROAD | LENGTH : 431mm WIDTH : 200mm HEIGHT : 127mm W/B : 254mm | 1.25 KG WITHOUT BATTERIES |
|  | RTR SPRINT 2 SPORT W/ FALKEN PORSCHE 911 GT3 RSR page 46 | #108220 | 1/10TH ELECTRIC | 4WD | BELT | ON-ROAD | LENGTH : 431mm WIDTH : 200mm HEIGHT : 127mm W/B : 254mm | 1.25 KG WITHOUT BATTERIES |
|  | SPRINT 2 SPORT RTR W/ 1969 MUSTANG RTR-X BODY page 41 | #109299 | 1/10TH ELECTRIC | 4WD | BELT | ON-ROAD | LENGTH : 431mm WIDTH : 200mm HEIGHT : 127mm W/B : 254mm | 1.25 KG WITHOUT BATTERIES |
|  | RTR SPRINT 2 DRIFT W/ 2010 CAMARO BODY page 47 | #106149 | 1/10TH ELECTRIC | 4WD | BELT | ON-ROAD | LENGTH : 431mm WIDTH : 200mm HEIGHT : 127mm W/B : 254mm | 1.25 KG WITHOUT BATTERIES |
|  | RTR SPRINT 2 DRIFT W/ NISSAN 350Z BODY page 47 | #106154 | 1/10TH ELECTRIC | 4WD | BELT | ON-ROAD | LENGTH : 431mm WIDTH : 200mm HEIGHT : 127mm W/B : 254mm | 1.25 KG WITHOUT BATTERIES |
|  | RTR SPRINT 2 FLUX W/ 2010 CAMARO BODY page 46 | #108765 | 1/10TH ELECTRIC FLUX | 4WD | BELT | ON-ROAD | LENGTH : 431mm WIDTH : 200mm HEIGHT : 127mm W/B : 254mm | 1.25 KG WITHOUT BATTERIES |
|  | SPRINT 2 FLUX RTR W/ MUSTANG GT-R BODY page 46 | #112710 | 1/10TH ELECTRIC FLUX | 4WD | BELT | ON-ROAD | LENGTH : 431mm WIDTH : 200mm HEIGHT : 127mm W/B : 254mm | 1.25 KG WITHOUT BATTERIES |
|  | SPRINT 2 FLUX RTR W/ BMW M3 GTS ORANGE BODY page 46 | #112862 | 1/10TH ELECTRIC FLUX | 4WD | BELT | ON-ROAD | LENGTH : 431mm WIDTH : 200mm HEIGHT : 127mm W/B : 254mm | 1.25 KG WITHOUT BATTERIES |

micro RS4 evo+

One of our classic models, this nitro-powered touring car is available in both a muscle car and drift car version

| | | | | | | | | |
|---|---|---------|--------------|-----|-------|---------|--|---|
|  | NITRO RS4 3 EVO+ RTR W/ 1969 FORD MUSTANG RTR-X page 42 | #112619 | 1/10TH NITRO | 4WD | SHAFT | ON-ROAD | LENGTH : 431mm WIDTH : 200mm HEIGHT : 127mm W/B : 254mm | 1.75 KG WITHOUT FUEL & BATTERIES |
|  | NITRO 3 DRIFT RTR W/ DISCOUNT TIRE/ NISSAN S-13 BODY page 43 | #112587 | 1/10TH NITRO | 4WD | SHAFT | ON-ROAD | LENGTH : 431mm WIDTH : 200mm HEIGHT : 127mm W/B : 254mm | 1.75 KG WITHOUT FUEL & BATTERIES |

E10

Our starter-level touring car is designed as the ideal introduction to on-road fun and can fit all of our touring car wheels and bodies for a huge range of different styles

| | | | | | | | | |
|---|--|---------|-----------------|-----|-------|---------|--|---------------------------------|
|  | RTR E10 DRIFT W/ DISCOUNT TIRE/ FALKEN NISSAN S13 | #109291 | 1/10TH ELECTRIC | 4WD | SHAFT | ON-ROAD | LENGTH : 431mm WIDTH : 200mm HEIGHT : 127mm W/B : 254mm | 1.25 KG WITHOUT BATTERIES |
|  | E10 RTR W/ 2014 FORD MUSTANG RTR BODY | #109494 | 1/10TH ELECTRIC | 4WD | SHAFT | ON-ROAD | LENGTH : 431mm WIDTH : 200mm HEIGHT : 127mm W/B : 254mm | 1.25 KG WITHOUT BATTERIES |
|  | E10 DRIFT RTR FALKEN TIRE 2013 FORD MUSTANG | #111277 | 1/10TH ELECTRIC | 4WD | SHAFT | ON-ROAD | LENGTH : 431mm WIDTH : 200mm HEIGHT : 127mm W/B : 254mm | 1.25 KG WITHOUT BATTERIES |
|  | E10 DRIFT RTR VAUGHN GITTIN JR/ MONSTER ENERGY/ NITRO TIRE 2013 FORD MUSTANG RTR | #111664 | 1/10TH ELECTRIC | 4WD | SHAFT | ON-ROAD | LENGTH : 431mm WIDTH : 200mm HEIGHT : 127mm W/B : 254mm | 1.25 KG WITHOUT BATTERIES |

Wheely King
4x4
Crawler King

For huge fun, the Wheely King just can't be topped, and if you want pure off-road rock crawling performance look at its Crawler King brother

| PART NO. | SCALE | POWER | DRIVE | D/TYPE | SURFACE | DIMENSIONS | WEIGHT |
|---|--------|----------|-------|--------|----------|--|------------------------------|
| RTR WHEELY KING 4X4 page 30 | 1/12TH | ELECTRIC | 4WD | SHAFT | OFF-ROAD | LENGTH : 231mm WIDTH : 297mm HEIGHT : 254mm W/B : 239mm | 2.6 KG WITHOUT BATTERIES |
| CRAWLER KING FORD BRONCO BODY page 30 | 1/10TH | ELECTRIC | 4WD | SHAFT | OFF-ROAD | LENGTH : 450mm WIDTH : 285mm HEIGHT : 280mm W/B : 300mm | 2.05 KG WITHOUT BATTERIES |
| CRAWLER KING RTR W/ FORD RAPTOR BODY page 31 | 1/10TH | ELECTRIC | 4WD | SHAFT | OFF-ROAD | LENGTH : 450mm WIDTH : 285mm HEIGHT : 280mm W/B : 300mm | 2.05 KG WITHOUT BATTERIES |

TRAXXAS

The perfect introduction to RC for anyone that wants a simple, small truck, this mini-size 4WD monster is huge palm-sized fun

| | | | | | | | |
|--|--------|----------|-----|-------|----------|--|-----------------------------|
| RTR MINI RECON W/ SQUAD ONE page 25 | 1/18TH | ELECTRIC | 4WD | SHAFT | OFF-ROAD | LENGTH : 232mm WIDTH : 174mm HEIGHT : 108mm W/B : 160mm | 0.5 KG WITHOUT BATTERIES |
|--|--------|----------|-----|-------|----------|--|-----------------------------|

MICRO RS4

The perfect size for indoor fun, this tiny on-road car can be a drifter or street racer for maximum fun

| | | | | | | | |
|---|--------|----------|-----|------|---------|---|-----------------------------|
| KEN BLOCK 2015 Grid MICRO RS4 RTR W/ FORD FIESTA page 13 | 1/18TH | ELECTRIC | 4WD | BELT | ON-ROAD | LENGTH : 227mm WIDTH : 105mm HEIGHT : 80mm W/B : 140mm | 0.3 KG WITHOUT BATTERIES |
| MICRO RS4 RTR W/ 1969 FORD MUSTANG RTR-X page 41 | 1/18TH | ELECTRIC | 4WD | BELT | ON-ROAD | LENGTH : 245mm WIDTH : 105mm HEIGHT : 80mm W/B : 140mm | 0.3 KG WITHOUT BATTERIES |

QBE

The smallest car you can get from HPI, this tiny racer is ideal for playing and racing indoors, and features RealSteer™ tech for true RC driving

| | | | | | | | |
|---|--------|----------|-----|-----|---------|---|-----------------------|
| Q32 BAJA BUGGY RTR page 24 | 1/32ND | ELECTRIC | 2WD | RWD | ON-ROAD | LENGTH : 110mm WIDTH : 75mm HEIGHT : 44mm W/B : 82mm | 43.5g INC. BATTERY |
| Q32 D8T Tessmann Edition RTR page 25 | 1/32ND | ELECTRIC | 2WD | RWD | ON-ROAD | LENGTH : 110mm WIDTH : 75mm HEIGHT : 44mm W/B : 82mm | 43.5g INC. BATTERY |
| FORUMAL Q32 Blue Body page 24 | 1/32ND | ELECTRIC | 2WD | RWD | ON-ROAD | LENGTH : 110mm WIDTH : 75mm HEIGHT : 44mm W/B : 82mm | 43.5g INC. BATTERY |
| FORUMAL Q32 Red Body page 24 | 1/32ND | ELECTRIC | 2WD | RWD | ON-ROAD | LENGTH : 110mm WIDTH : 75mm HEIGHT : 44mm W/B : 82mm | 43.5g INC. BATTERY |



Get more out of your HPI experience when you register your HPI vehicle on the MYhpi website! You'll be informed of the latest options, videos, tutorials and more, direct from HPI and straight to your inbox! We'll tell you about HPI events near you, keep you updated on the newest products you're interested in and to top it all off you can win awesome FREE prizes from HPI!

my.hpiracing.com



CONNECT WITH HPI AND WIN BIG!

When you share your enthusiasm for your HPI kit, you can win big! All you have to do is share a video of yourself showing off your HPI kit and say "This is MY hpi!" – tag the video with #myhpi then email the video link to win@hpiracing.com to make sure we see it! For details of the contest rules as well as terms and conditions, please see hpiracing.com/win





MEET OUR FACTORY TEAM DRIVERS



SWEDISH 1/8TH OFF-ROAD NATIONAL CHAMPIONSHIP



KEEP UP TO DATE WITH THE HB TEAM



INTRODUCTION TO HB-HPI RACING

HB is the racing arm of HPI Racing: a small yet perfectly-sized team of dedicated racers, designers and mechanics with an amazing depth of talent with one goal: to achieve race wins. The factory team is made up a core of less than a dozen factory racers across all disciplines – nitro, electric, on-road and off-road – and consists of multiple World, European and ROAR champions, plus highly talented up-and-coming racers. The factory team then passes their knowledge to our highly motivated regional and local HB racers across the globe, giving us the large and growing HB Infantry.

This versatility and deep talent gives Team HB the flexibility to take wins and trophies around the world, and the race-winning design makes it into every HB and HPI kit.



ROAD TO BECOMING WORLD CHAMPION



2014: TY BECAME WORLD CHAMPION



2012: WORLDS TQ AND FINISHED 2ND PLACE



2010: MADE WORLDS SEMI FINAL



2006: WON HIS FIRST CANADA NATIONALS



2004: SIGNED FOR TEAM HB



PRO5

R10

R8

#108382 HB R10

*Bodyshell, engine, exhaust, electronics, tires and radio system required to complete the car.

110754 HB R8

*Bodyshell, engine, exhaust, electronics, tires and radio system required to complete the car.

CHECK OUT THE FACEBOOK PAGE

NITRO TOURING CAR RACING AT ITS FINEST

The HB R10 is the latest kit from the minds at HB-HPI to enter the exciting and fast world of 1/10th scale on-road touring car racing! This time, we're diving into the nitro end of the racing arena, with a unique, high-spec nitro touring car kit that is sure to amaze nitro racing fans!

DOWNLOAD AND FOLLOW PRO SETUP SHEETS...

WORLD CLASS NITRO 8TH SCALE

The R8 is a fresh new design, aimed at taking on the fastest and most exciting on-road racing class: 1/8th Nitro On-Road! With an extremely low center of gravity, thick aluminum chassis, graphite upper deck and shock towers, centrally-mounted components and more smart design throughout, the HB R8 is the car to have when racing with the best.

#107244 - HPI/HB HAULER BAG

#114987 - #114992 HB HPI CHAMPIONSHIP HOODIE sizes S to XXL

#114170 - #114175 HB RACING ESTABLISHED T-SHIRT sizes S to XXXL

#101998 - HPI/HB RACING PARTS TRAY (SMALL/BLACK)

#101997 - HPI/HB RACING PIT MAT (LARGE/BLACK)

WORLD-BEATING ELECTRIC TC TECH

The PRO5 is a culmination of the latest trends and developments in electric touring car racing, and is track-tested, rebuilt and dialled in week after week at race tracks around the world. Team HB has put in thousands of hours to make the HB PRO5 the best available touring car you can get today.

#114500 HB PRO5

*Bodyshell, electronics, wheels, tires and radio system required to complete the car.

D413

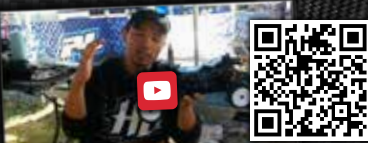

MEET THE D413 DESIGNER

BACK-TO-BACK NATIONAL CHAMPION

The HB D413 was already a legend before it was released to the public – designed in just under a year by HB Designer Torrance Deguzman and piloted by RC legend Ty Tessmann, the D413 made history by becoming the US National Champion in 2013, then taking another win in 2014! This is the most versatile and durable 4WD buggy you can get today!

#112723 HB D413
*4WD racing buggy kit with no electronics.



TEAM HB AT THE EFRA 1/10 BUGGY EUROS 2015

D216



2WD BUGGY DESIGNED FOR CHAMPIONS

Developed by HB D413 designer Torrance Deguzman with the help of HB team drivers including Ty Tessmann, the D216 represents another bold, fresh step forward for racing buggies. The sturdy character and high adjustability of its 4WD brother carries over to the D216, giving you maximum choice and tuning capability for high and low grip surfaces!

#116115 HB D216
*2WD racing buggy kit with no electronics.



D815

TESSMANN WORLDS EDITION



*Engine, exhaust, electronics, tires, inserts and radio system required to complete the car.

THE WORLD-BEATING NITRO BUGGY

Just to even attend the World Championships is a 2-year long struggle. Running at the top of the field in practice, dominating qualifying and then lapping the entire grid (twice!) in the grueling hour-long Final, held in the shadow of an active volcano...that's something else altogether! The HB D812 made history at the most recent IFMAR World Championships and helped solidify Ty Tessmann at the top of a very short list of "World's Fastest Drivers".

#114615 HB D815 Tessmann Worlds Edition Kit



D8T

TESSMANN Edition

D8T TESSMANN Edition Q82 CHECK IT OUT on page 23

THE ULTIMATE TRUGGY DEVELOPED BY THE ULTIMATE RACER

Team Tessmann have been hard at work for the past few years, working next to HB designers to develop the D8T into the Ty Tessmann Edition, packed full of race-winning upgrades, tweaks and adjustments directly from Ty himself! The results? Winning the Pro-Line Dual, 3 consecutive Dirt Nitro Challenge wins and a US National Championship! Loaded with aluminum and carbon fiber, as well as new suspension parts, Pro-Line body and Upgrade R/C wing, the only option part not included is Ty himself!

#113391 HB D8T Ty Tessmann Edition *No electronics, engine, wheels or tires.





RACE TIRES

hpi RACE DNA



2016 PRODUCT CATALOG
 ON-ROAD | OFF-ROAD | BODYSHELLS | ACCESSORIES

#92003 - ENGLISH
 4 944258 920030



2016 PRODUCT CATALOG
 ON-ROAD | OFF-ROAD | BODYSHELLS | ACCESSORIES

